

PARTS CATALOGUE

Tecna Display Ltd use only the highest quality materials and components in the fabrication of our framing systems. This means we are able to offer a lifetime guarantee on all our main system components.*

Look out for the T3 guarantee mark. 

(*see www.tecnadisplay.com for terms & conditions)

CAP

Cap for connector

Weight	3g
Material	Polycarbonate
Fire Rating	ULV-0
Pack Quantity	1



CON

Connector

Weight	22g
Material	Polycarbonate
Fire Rating	ULV-0
Pack Quantity	1



DBJ

Double Joiner

Width	14mm
Weight	10g
Material	Polycarbonate
Fire Rating	ULV-0
Pack Quantity	1

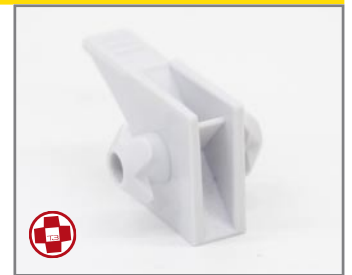
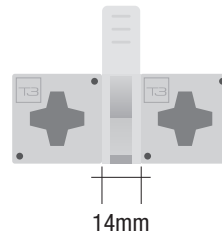

AF089

Angled fitting 7.5° to 75°

Weight	approx. 59g (dependant on angle)
Pack Quantity	1

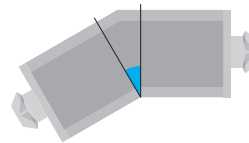

I8

M8 tube insert

Weight	2g
Material	Aluminium
Pack Quantity	1



I10

M10 tube insert

Weight	2g
Material	Aluminium
Pack Quantity	1



FA25

25mm foot - height & tilt adjustable

Diameter	25mm
Weight	26g
Pack Quantity	1



FA40

40mm foot - height & tilt adjustable

Diameter	40mm
Weight	33g
Pack Quantity	1



FA55

55mm foot - height & tilt adjustable

Diameter	55mm
Weight	40g
Pack Quantity	1



FA38

38mm foot - height adjustable for use with M8 threaded insert

Diameter	38mm
Weight	23g
Pack Quantity	1



FA70

70mm foot - height adjustable for use with M10 threaded insert

Diameter	70mm
Weight	42g
Pack Quantity	1



UBC

Unbraked wheel for use with M8 threaded insert

Weight	95g
Pack Quantity	1



BC

Braked wheel for use with M8 threaded insert

Weight	98g
Pack Quantity	1



EFM5

Bayonet fitting with M5 brass insert

Weight	6g
Material	Polycarbonate
Fire Rating	ULV-0
Pack Quantity	1



EFS

Bayonet fitting with M8 thread

Weight	4g
Material	Polycarbonate
Fire Rating	ULV-0
Pack Quantity	1



HNG

Hinge

Weight	12g
Material	Polycarbonate
Fire Rating	ULV-0
Pack Quantity	1



SHCLMP

Clamp for fixing T3 Fabframe/Airframe to shell schemes

Weight	60g
Material	Aluminium
Pack Quantity	1

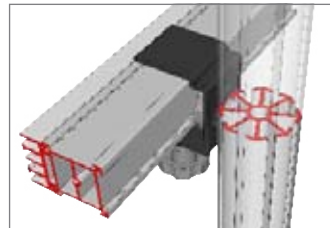

EX206-MS

206mm angled extrusion, magnetic 1 side, steel 1 side for BM245

Length	206mm
Weight	93g
Pack Quantity	1



EX451-MS

451mm angled extrusion magnetic 1 side, steel 1 side for BM490

Length	451mm
Weight	202g
Pack Quantity	1



EX696-MS

696mm angled extrusion magnetic 1 side, steel 1 side for BM735

Length	696mm
Weight	312g
Pack Quantity	1



EX941-MS

941mm angled extrusion magnetic 1 side, steel 1 side for BM980

Length	941mm
Weight	422g
Pack Quantity	1



EX1186-MS

1186mm angled extrusion magnetic 1 side, steel 1 side for BM1225

Length	1186mm
Weight	532g
Pack Quantity	1



EX1431-MS

1431mm angled extrusion magnetic 1 side, steel 1 side for BM1470

Length	1431mm
Weight	642g
Pack Quantity	1



EXCUST

Custom length angled extrusion magnetic 1 side, steel 1 side

Length	From 16mm to 3000mm
Weight	449g per metre



T3 Airframe Classic profile is a 33x33mm aluminium tube with a 0.75mm recess to all four sides. The tube can be used with steel or velcro inset strips for the attachment of rigid and flexible panels.

Please note; all weights are approximate and are subject to material and manufacturing tolerances.

Tecna Display Ltd strongly recommend that all sizes for graphics are measured from the built structure.

Tecna Display Ltd do not accept responsibility for incorrect graphic sizes.

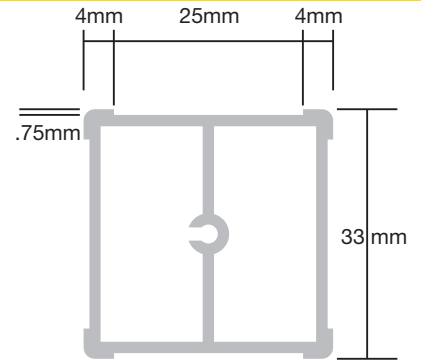

CL-ESC

End stop cap for tube

Weight	6g
Material	Nylon
Pack Quantity	1



CL-EFS

Tube end fitting inc. screw

Weight	8g (inc. screw)
Material	Polycarbonate
Fire Rating	ULV-0
Pack Quantity	1

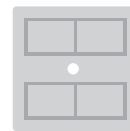

Reverse of tube end fitting



CLB245-S2

245mm c/c Classic profile tube, steel 2 sides c/w end fittings

Length	245mm c/c - 212mm tube
Weight	182g
Pack Quantity	1

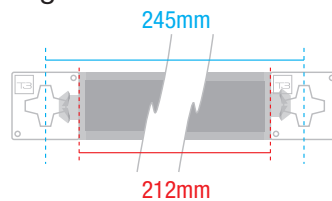

CLB490-S2

490mm c/c Classic profile tube, steel 2 sides c/w end fittings

Length	490mm c/c - 457mm tube
Weight	379g
Pack Quantity	1

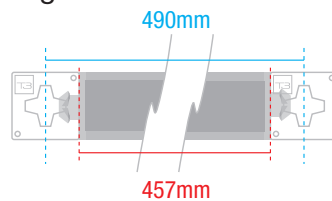

CLB735-S2

735mm c/c Classic profile tube, steel 2 sides c/w end fittings

Length	735mm c/c - 702mm tube
Weight	576g
Pack Quantity	1

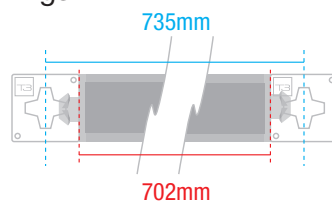

CLB980-S2

980mm c/c Classic profile tube, steel 2 sides c/w end fittings

Length	980mm c/c - 947mm tube
Weight	773g
Pack Quantity	1

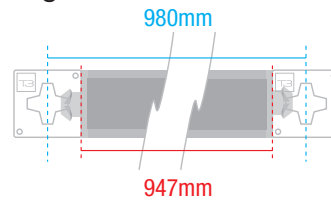

CLB1225-S2

1225mm c/c Classic profile tube, steel 2 sides c/w end fittings

Length	1225mm c/c - 1192mm tube
Weight	969g
Pack Quantity	1

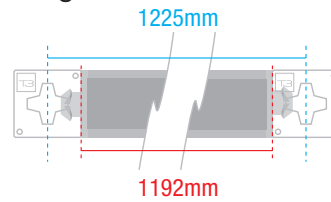

CLB1470-S2

1470mm c/c Classic profile tube, steel 2 sides c/w end fittings

Length	1470mm c/c - 1437mm tube
Weight	1167g
Pack Quantity	1

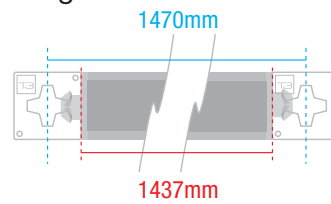

CLBCUST-T0

Custom length Classic profile tube, no steel or end fittings

Length	From 16mm to 3000mm
Weight	703g per metre



CLBCUST-S2

Custom length Classic profile tube, steel 2 sides c/w end fittings

Length	From 16mm to 3000mm
Weight	848g per metre



CLC490/90-S2

490mm Ø c/c, 90° curve Classic profile tube, steel 2 sides c/w end fittings

Diameter Ø c/c	490mm
Inside length c/c	359mm
Outside length c/c	411mm
Weight	299g
Pack Quantity	1

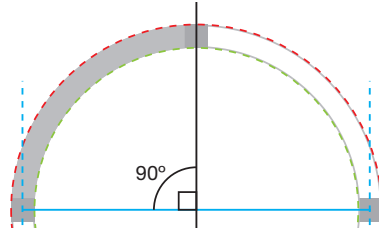

CLC735/90-S2

735mm Ø c/c, 90° curve Classic profile tube, steel 2 sides c/w end fittings

Diameter Ø c/c	735mm
Inside length c/c	551mm
Outside length c/c	603mm
Weight	453g
Pack Quantity	1

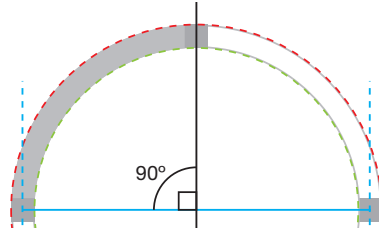

CLC980/90-S2

980mm Ø c/c, 90° curve Classic profile tube, steel 2 sides c/w end fittings

Diameter Ø c/c	980mm
Inside length c/c	744mm
Outside length c/c	796mm
Weight	609g
Pack Quantity	1

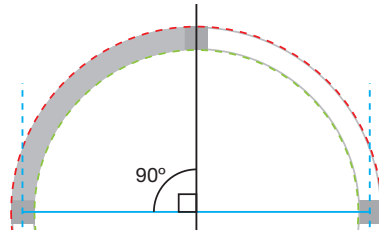

CLC1225/90-S2

1225mm Ø c/c, 90° curve Classic profile tube, steel 2 sides c/w end fittings

Diameter Ø c/c	1225mm
Inside length c/c	936mm
Outside length c/c	988mm
Weight	721g
Pack Quantity	1

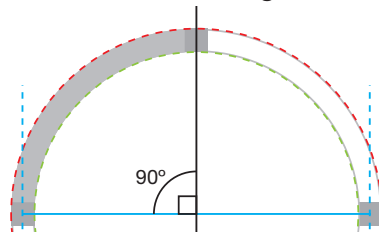

CLC1470/45-S2

1470mm Ø c/c, 45° curve Classic profile tube, 2 sides c/w end fittings

Diameter Ø c/c	1470mm
Inside length c/c	564mm
Outside length c/c	590mm
Weight	443g
Pack Quantity	1

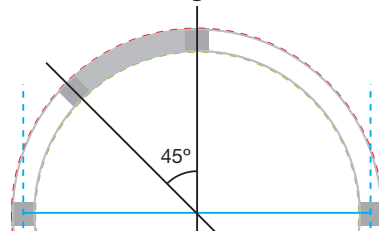

CLCCUST-S2

Custom diameter Classic profile curve c/c steel 2 sides c/w end fittings

Diameter	From 495mm c/c to 8000mm c/c
Weight	804g per metre
Pack Quantity	1



CL-DFF

Door full height

Outer Dimensions	2029(h)mm x 768(w)mm
Opening Dimensions	1996(h) x 720(w)mm
Weight	11kg
Pack Quantity	1



CL-DFC

Curved door full height

Outer Dimensions	2029(h)mm x 802(w)mm (based on 2940mm Ø c/c)
Opening Dimensions	1996(h) x 720(w)mm
Weight	11.3kg
Pack Quantity	1



CL-DCF

Cupboard door

Outer Dimensions	1013(h)mm x 768(w)mm
Opening Dimensions	947(h) x 702(w)mm
Weight	5.2kg
Pack Quantity	1

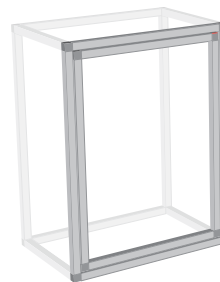

CL-DCC

Curved cupboard door

Outer Dimensions	1013(h)mm x 768(w)mm (based on 980mm Ø c/c)
Opening Dimensions	947(h) x 646(w)mm
Weight	5.4kg
Pack Quantity	1



T3 Airframe Channel profile is a 33x33mm aluminium tube with a 23mm channel to all four sides. The tube can be used with various inserts for the attachment of all types of panels and shelves.

Please note; all weights are approximate and are subject to material and manufacturing tolerances.

Tecna Display Ltd strongly recommend that all sizes for graphics are measured from the built structure.

Tecna Display Ltd do not accept responsibility for incorrect graphic sizes.

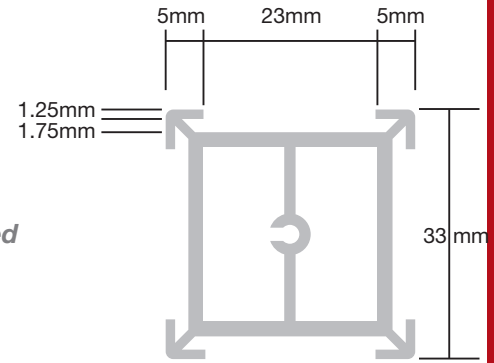

CH-EFS

Tube end fitting inc. screw

Weight	8g (inc. screw)
Material	Polycarbonate
Fire Rating	ULV-0
Pack Quantity	1

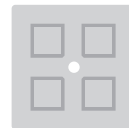

Reverse of tube end fitting



CH-DT

Decor insert

Length	15mm to 2000mm
Weight	66g per metre
Material	UPVC
Fire Rating	ULV-0



CH-SP

Shelf/Panel support insert

Length	16mm to 2000mm
Weight	120g per metre
Material	UPVC
Fire Rating	ULV-0



CHB245

245mm c/c Channel profile tube, c/w end fittings

Length	245mm c/c - 212mm tube
Weight	-
Pack Quantity	1

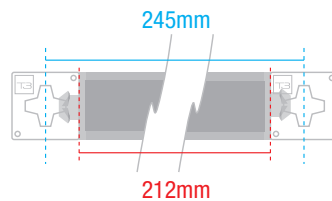

CHB490

490mm c/c Channel profile tube, c/w end fittings

Length	490mm c/c - 457mm tube
Weight	-
Pack Quantity	1

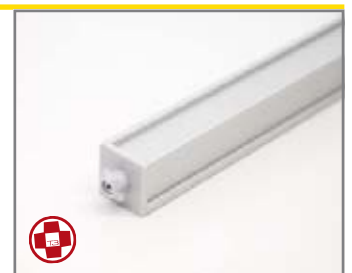
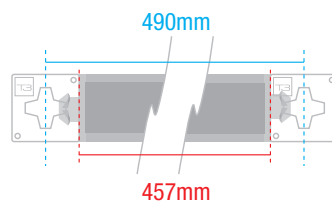

CHB735

735mm c/c Channel profile tube, c/w end fittings

Length	735mm c/c - 702mm tube
Weight	-
Pack Quantity	1

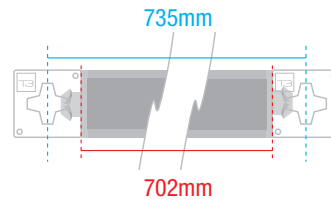

CHB980

980mm c/c Channel profile tube, c/w end fittings

Length	980mm c/c - 947mm tube
Weight	-
Pack Quantity	1

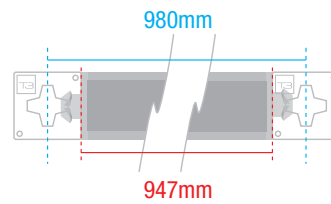

CHB1225

1225mm c/c Channel profile tube, c/w end fittings

Length	1225mm c/c - 1192mm tube
Weight	-
Pack Quantity	1

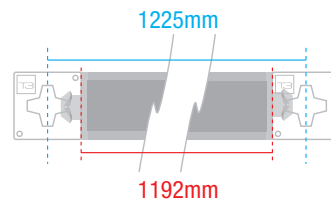

CHB1470

1470mm c/c Channel profile tube, c/w end fittings

Length	1470mm c/c - 1437mm tube
Weight	-
Pack Quantity	1

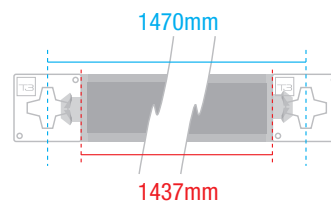

CHB1715

1715mm c/c Channel profile tube, c/w end fittings

Length	1715mm c/c - 1682mm tube
Weight	-
Pack Quantity	1

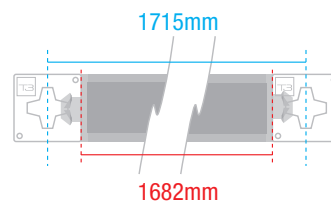

CHB1960

1960mm c/c Channel profile tube, c/w end fittings

Length	1960mm c/c - 1927mm tube
Weight	-
Pack Quantity	1

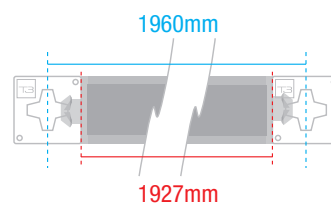

CHC1715/60

1715mm Ø c/c, 60° curve Channel profile tube, end fittings

Diameter Ø c/c	1715mm
Inside length c/c	881mm
Outside length c/c	915mm
Weight	584g
Pack Quantity	1

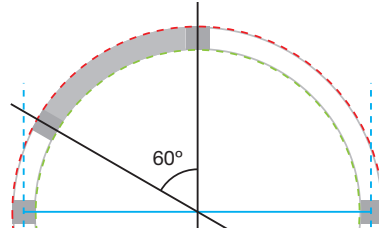

CHC1960/60

1960mm Ø c/c, 60° curve Channel profile tube, end fittings

Diameter Ø c/c	1960mm
Inside length c/c	1009mm
Outside length c/c	1043mm
Weight	666g
Pack Quantity	1

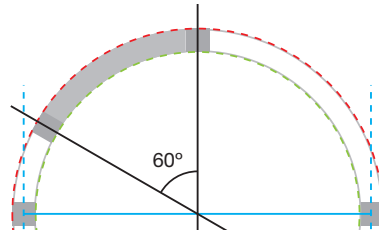

CHC2450/45

2450mm Ø c/c, 45° curve Channel profile tube, end fittings

Diameter Ø c/c	2450mm
Inside length c/c	949mm
Outside length c/c	975mm
Weight	625g
Pack Quantity	1

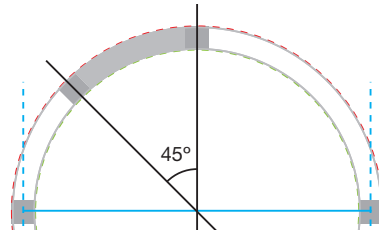

CHC2940/45

2940mm Ø c/c, 45° curve Channel profile tube, end fittings

Diameter Ø c/c	2940mm
Inside length c/c	1141mm
Outside length c/c	1167mm
Weight	746g
Pack Quantity	1

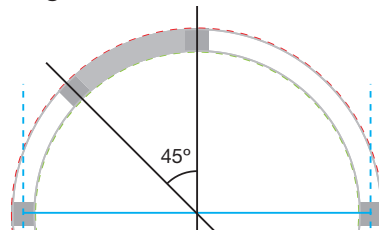

CHC3430/30

3430mm Ø c/c, 30° curve Channel profile tube, end fittings

Diameter Ø c/c	3430mm
Inside length c/c	889mm
Outside length c/c	907mm
Weight	584g
Pack Quantity	1

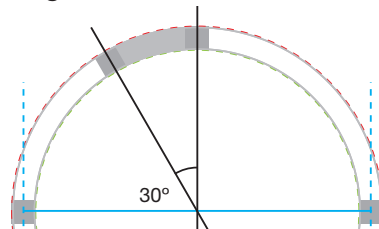

CHC3920/30

3920mm Ø c/c, 30° curve Channel profile tube, end fittings

Diameter Ø c/c	3920mm
Inside length c/c	1018mm
Outside length c/c	1035mm
Weight	650g
Pack Quantity	1

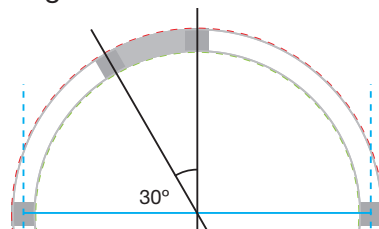

CHC4410/22.5

4410mm Ø c/c, 22.5° curve Channel profile tube, end fittings

Diameter Ø c/c	4410mm
Inside length c/c	859mm
Outside length c/c	872mm
Weight	564g
Pack Quantity	1

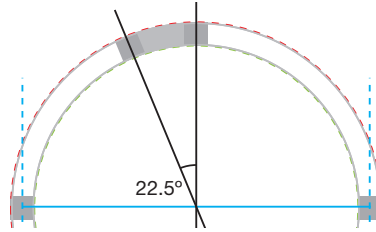

CHC4900/22.5

4900mm Ø c/c, 22.5° curve Channel profile tube, end fittings

Diameter Ø c/c	4900mm
Inside length c/c	956mm
Outside length c/c	968mm
Weight	625g
Pack Quantity	1

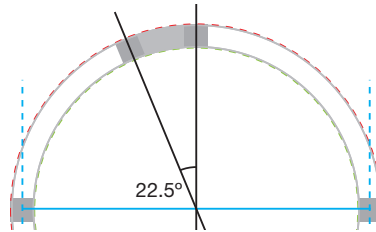

CHC5390/22.5

5390mm Ø c/c, 22.5° curve Channel profile tube, end fittings

Diameter Ø c/c	5390mm
Inside length c/c	1052mm
Outside length c/c	1065mm
Weight	686g
Pack Quantity	1

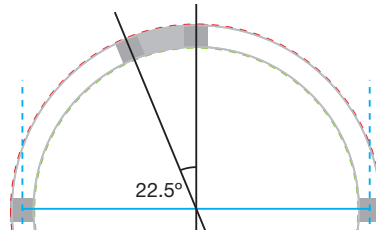

CHC5880/22.5

5880mm Ø c/c, 22.5° curve Channel profile tube, end fittings

Diameter Ø c/c	5880mm
Inside length c/c	1148mm
Outside length c/c	1161mm
Weight	746g
Pack Quantity	1

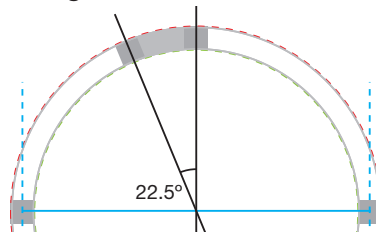

CHBCUST

Custom cut straight T3 Airframe Channel Profile tube

Length	From 16mm to 3000mm
Weight	633g per metre
Material	Aluminium



CHCCUST

Custom cut curved T3 Airframe Channel Profile tube

Diameter	From 1750mm Ø c/c to 8000mm Ø c/c
Weight	633g per metre
Material	Aluminium



THG

T3 Graphic Hanger

Weight 9g (each)
 Material Polycarbonate
 Pack Quantity 2
 Attached with 3M tape specified for plastic to plastic

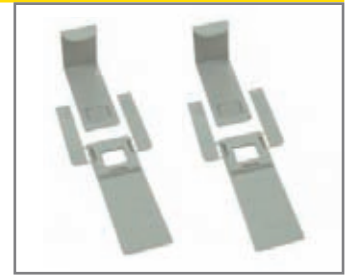

SPL

Spotlight Tungsten halogen c/w T3 clamp

Weight 708g (inc. lead & clamp)
 Power 150W
 Pack Quantity 1
 CE Certified



PSS

Plasma screen support

Size 735 x 367.5mm c/c
 Weight 4kg
 Pack Quantity 1
 Plasma screen bracket is screwed/fitted to wooden board.



TSR

Steel tape

Size 147m x 25mm
 Weight 10kg
 Pack Quantity 1



THB

Double sided high bond adhesive tape

Size 50m x 25mm
 Weight 360g
 Pack Quantity 1



LWC

Large case with foam interior, 4 rotating wheels and 2 fitted luggage straps

Internal dimensions	345(w) x 325(d) x 1265(l)mm
Weight	9.1kg
Max. Load	100kg - 90 tubes at 1260mm long
Pack Quantity	1



MCN

Medium case with foam interior, 2 fixed wheels and 2 fitted luggage straps

Internal dimensions	290(w) x 250(d) x 960(l)mm
Weight	8.1kg
Max. Load	46kg - 56 tubes at 951mm long
Pack Quantity	1



CGC

Circular graphics drum

Internal dimensions	300mm Ø x 980(l)mm
Weight	4kg
Capacity	up to 15m graphic panels
Pack Quantity	1



CBS

Carry bag small

Internal dimensions	340(w) x 220(d) x 350(h)mm
Weight	1kg
Capacity	360 connectors
Pack Quantity	1



AVAILABLE MAY '09

CBM

Carry bag medium

Internal dimensions	1050(w) x 210(d) x 210(h)mm
Weight	1.6kg
Capacity	36 x 980cc tubes
Pack Quantity	1



AVAILABLE MAY '09

CBL

Carry bag large

Internal dimensions	1300(w) x 210(d) x 170(h)mm
Weight	2kg
Capacity	30 x 1250cc tubes
Pack Quantity	1



AVAILABLE MAY '09

CBXL

Carry bag extra large

Internal dimensions	1550(w) x 170(d) x 170(h)mm
Weight	2.6kg
Capacity	25 x 1450cc tubes
Pack Quantity	1



AVAILABLE MAY '09